



Televes reserves the right to modify the product

## EuroSwitch 5 inputs - 16 outputs

### Compact and effective for large installations

Compact multiswitch equipped with 5 inputs (one terrestrial, and the four polarities of one satellite) and 16 user outputs.

Thanks to its great compactness and its optimized electronic design, it presents very low through and tap losses. This allows to reduce the number of amplifiers needed in the cascade and to obtain a better balanced signal in the users, even in large collective installations.

Can be used as a terminal (star topology) or as a cascade by using a simple switch. In addition, it incorporates a second switch that activates the TForce technology, which automatically adjusts the terrestrial signal and keep it constant despite variations in the reception.

RED compliant

Ref.719505

Art.Nr

MSE516C

EAN13

8424450246733

## Highlights

- Very compact in dimensions and weight, even in models with high number of users
- Very low through and tap losses
- Great isolation between inputs and outputs
- Equipped with the TForce technology, the terrestrial output level is automatically adjusted (TERR. AMP. ACTIVE) to the optimal level
- 10 dB Low Gain (LG) / High Gain (HG) switch for the attenuation of the satellite input signal for each 8-user group
- Several powering options: From the power supply, from the cascade through the satellite inputs or outputs, or directly from the satellite receiver (RECEIVER POWER ACTIVE)
- 100% european design, quality, and manufacturing

## Main features

---

- High shielding (A class) thanks to its manufacture in Zamak
- Versatile: selector switch to shift between cascade and terminal modes
- Low consumption under normal conditions. In addition, ECO mode reduces consumption as the number of connected users decreases
- Wide 12-18V power supply range, making it compatible with most existing systems
- Current circulation between all inputs and cascades
- Input and output colour identification

## Application example

(Click to see the picture)

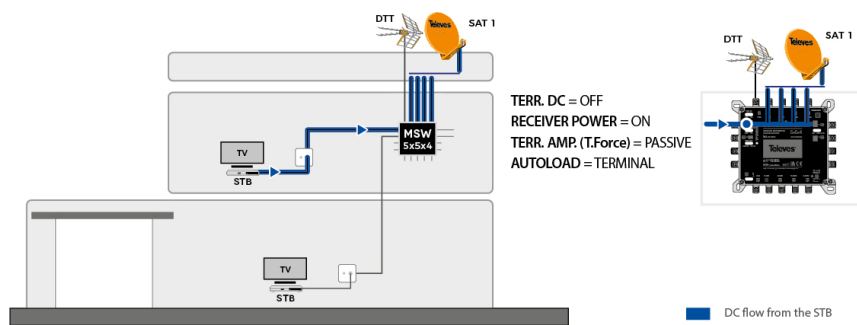

### Installation into a family-house (1 satellite)

The LNB and the multiswitch are powered from the user output by the STB, turning on the “RECEIVER POWER” switch. A PSU is not required.

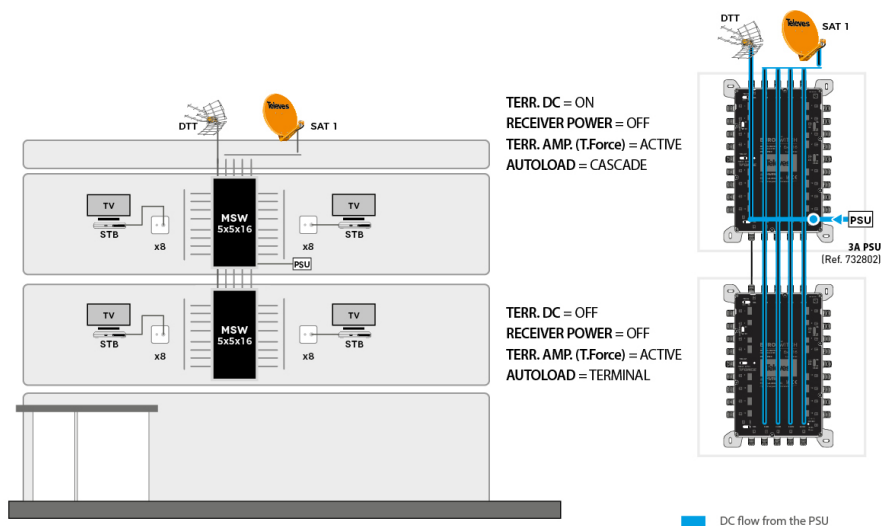

## Installation into a small multi dwelling unit (1 satellite)

The LNB, terrestrial antenna and the whole cascade of multiswitches is powered by a single 3A PSU. Thanks to "RECEIVER POWER" switched off, STBs are DC isolated from the cascade and protected against overcurrent.

## Technical specifications

Number of inputs		5
Number of cascadable outputs		5
Number of user outputs		16
Frequency range TERR.	MHz	88 ... 862
Frequency range SAT.	MHz	950 ... 2400
Input level TERR.	dB $\mu$ V	80 ... 110
Input level SAT.	dB $\mu$ V	65 ... 112
Through losses TERR.	dB	< 4
Through losses SAT.	dB	2 ... 3.5
Tap losses TERR. Active	dB	0 ... 4
Tap losses TERR. Passive	dB	32
Tap losses SAT. HG	dB	2 ... 7
Tap losses SAT. LG	dB	12 ... 14
Output level 10Ch DVB-T	dB $\mu$ V	78
Isolation H/V	dB	> 50
Isolation users	dB	> 30
Powering	Vdc	12 ... 18
Max. current (PSU - TERR ACT.)	mA	115 * <sup>1</sup>
Max. current (PSU - TERR PAS.)	mA	5
Max. current (STB)	mA	85
Operating temperature	°C	-5 ... 45
Protection index (IP)		20