

User Manual

Compact Satellite Converter Ref. 9780



SW Version 1.1.0.R

CONTENTS

1. INTRODUCTION	3
1.1. Product description	3
1.2. Typical installation	3
1.3. Package contents	3
1.4. Hardware installation	4
1.5. Mounting the Compact Satellite Convertor	4
1.6. Configuring the Compact Satellite Convertor	5
2. TECHNICAL SPECIFICATIONS	10
3. SAFETY INSTRUCTIONS	11
4. CONDITIONS OF WARRANTY	12
TEMPLATE FOR PRESET 1	13
TEMPLATE FOR PRESET 2	14

No part of this manual may be copied, reproduced, transmitted, transcribed or translated into any language without permission.

Unitron reserves the right to change the specifications of the hardware and software described in these manuals at any time.

Unitron cannot be held liable for any damages resulting from the use of this product. Specifications are subject to change without notice. 01/19

© Unitron - Frankrijklaan 27 - B-8970 Poperinge - Belgium

www.unitrongroup.com

1. INTRODUCTION

1.1. Product description

The 9780 is the new generation convertor for satellite signals to be used in MDU's. The compact plug-and-play module has a straightforward and easy configuration.

- programmable satellite IF convertor
- up to 32 DVB-S/S2 transponders
- 4 satellite inputs (Quattro/Quad/Wideband LNB)
- realtime AGC on all individual transponders
- read-out of input level strength: no need for field strength meter
- 112 dB μ V transponder output level

The state-of-the-art satellite convertor has no equivalent on the market due to its revolutionary technology:

- The most cost-efficient satellite convertor solution on the market
- Very easy and fast installation, without the need for a field strength meter
- Extremely sharp filters
- Perfect headend for your fibre installation to equalise and optimise the signals
- Excellent quality of the output signal, the 9780 optimises the incoming satellite signal to assure supreme video quality on the end-users' TV-screens
- To avoid unauthorized persons changing the settings, the Compact Satellite Convertor can be locked with a security code
- Made in Europe, for worldwide application
- 4 Satellite inputs
- 0-13-18V
- 0-22kHz
- Product dimensions (H X W X D): 165mm x 217mm x 59mm

1.2. Typical installation

The Compact Satellite Convertor can be used to provide high quality television images in a wide range of projects, both in the hospitality as in the residential market. Typical buildings or infrastructures where the Compact Satellite Convertor can be used include, but are not limited to:

- Large and small hotels, hostels, bed and breakfasts, holiday parks
- Hospitals, rest homes, prisons, settlements
- Large and small multi-dwelling units

1.3. Package contents

- 1 Compact Satellite Convertor (ref. 9780)
- 1 Power Adapter Cord (180cm)

1.4. Hardware installation

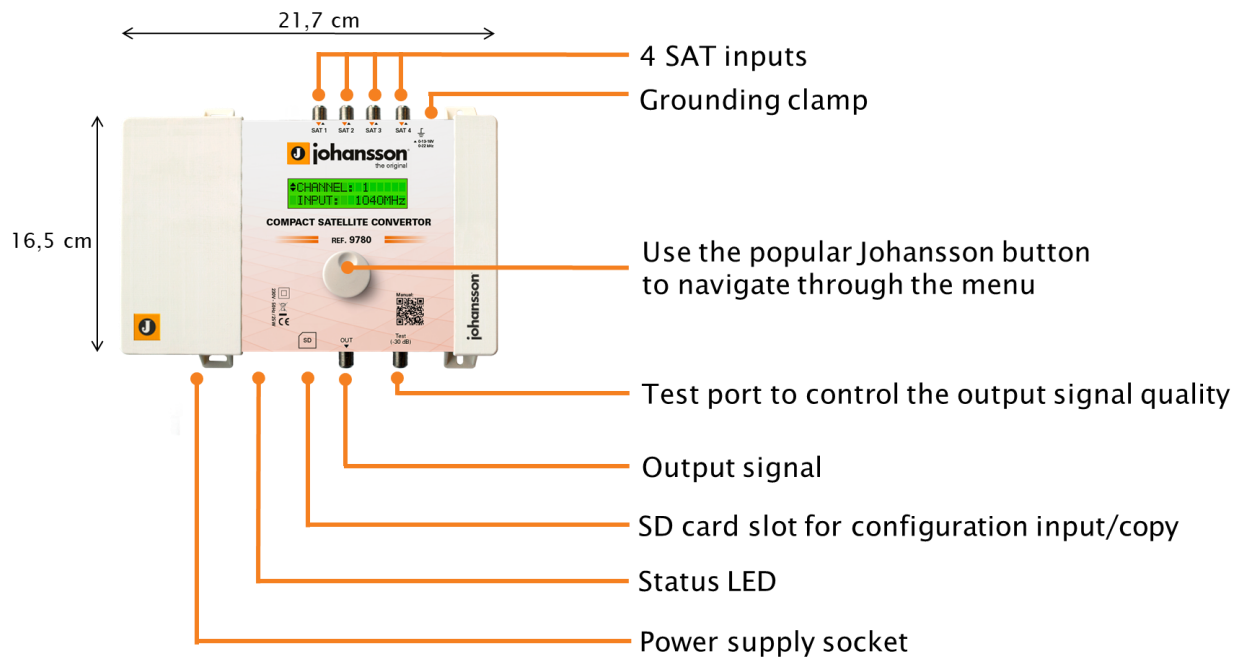
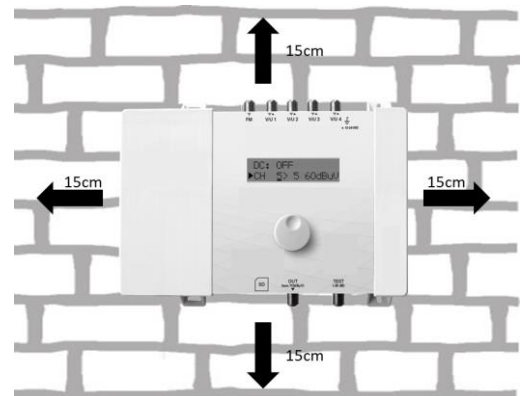

FIGURE 1: TOP VIEW OF PRODUCT

1.5. Mounting the Compact Satellite Converter



- **Important:** Mount the module vertically to a wall in a well-ventilated room and leave a minimum space of 15 cm around the product to guarantee a maximum ventilation of the product
- Connect an earth wire to the grounding clamp
- Connect the power adapter cord to the power supply socket. Check the status LED for the indication of DC power presence
- Connect the SAT inputs to the Compact Satellite Converter
- Connect a coaxial cable to the output connector for distribution of the signal
- Optionally: connect a network analyser to the test port to control the signal quality
- Configure the Compact Satellite Converter using the rotary button, see below
- Optionally: insert an SD card in the SD card slot to upload the configurations of a previous module or to copy the configuration to another module
- The power adapter can easily be replaced without disconnecting the product. To do so, open the top left plastic cover by pushing the click at the opposite side of the mains connector



1.6. Configuring the Compact Satellite Convertor

NAVIGATING THROUGH THE MENU

Use the Johansson rotary/push button to navigate through the menu. This is very straightforward and simple. The table below shows how the rotary/push should be used:

	<p>Push the button 2s to enter the basic configuration.</p> <p>Push the button to confirm your selections.</p>
	<p>When rotating the button, you scroll through the different screens.</p>



MENU OVERVIEW

◀▶		COPY INPUT 1	INPUT SAT 1 - 4	OUTPUT	ADVANCED	LOAD SD PRESET	SAVE SD PRESET	EXIT	▶◀	
		MODE	DC	LEVEL	LANGUAGE	PRESET X	CREATE PRESET	LOCK		
◄		START SCAN	ADD TRANSPONDER	SLOPE	FW VERSION		DELETE ALL	NO LOCK	►	
					SERIAL NUMBER					
					FORMAT CARD					

Push the rotary button for 2 seconds to access the menu

Note: On page 13 and 14 of this manual, you can find an easy template to prepare the transponder settings.

INPUT SETTINGS (AUTOSCAN) STARTING WITH COPY INPUT 1

DISPLAY READOUT	EXPLANATION
	Copy input: scan and detect the available transponders (up to 32) and put them on the output. Note: this function is only applicable for Input 1.
	MODE: choose your input signal and output signal and tap to confirm (see table below)

The following COPY INPUT 1 modes are possible:

MODE	INPUT SIGNAL	OUTPUT SIGNAL
OFF	-	-
Qlo → Qlo	QUATTRO LOW (950 MHz - 1950 MHz)	QUATTRO LOW (950 MHz - 1950 MHz)
Qlo → Wlo	QUATTRO LOW (950 MHz - 1950 MHz)	WIDEBAND LOW (290 MHz - 1290 MHz)
Wlo → Qlo	WIDEBAND LOW (290 MHz - 1290 MHz)	QUATTRO LOW (950 MHz - 1950 MHz)
Wlo → Wlo	WIDEBAND LOW (290 MHz - 1290 MHz)	WIDEBAND LOW (290 MHz - 1290 MHz)
Qhi → Qhi	QUATTRO HIGH (1100 MHz - 2150 MHz)	QUATTRO HIGH (1100 MHz - 2150 MHz)
Qhi → Whi	QUATTRO HIGH (1100 MHz - 2150 MHz)	WIDEBAND HIGH (1290 MHz - 2340 MHz)
Whi → Qhi	WIDEBAND HIGH (1290 MHz - 2340 MHz)	QUATTRO HIGH (1100 MHz - 2150 MHz)
Whi → Whi	WIDEBAND HIGH (1290 MHz - 2340 MHz)	WIDEBAND HIGH (1290 MHz - 2340 MHz)
W → W	WIDEBAND (290 MHz - 2340 MHz)	WIDEBAND (290 MHz - 2340 MHz)*

* NOTE: although this mode scans the full band, only the first 32 transponders will be selected

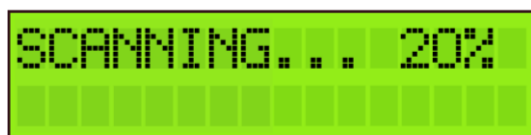







Scroll down to START SCAN and tap the rotary button



Scanning might take up to 30 seconds
When scanning is done, the number of found transponders will be shown



If you want to change the auto scan results, you can find the selected transponders via COPY INPUT 1 in the INPUT SAT 1 menu. There they can be modified if necessary (see next page).

INPUT SETTINGS (MANUAL) STARTING WITH INPUT SAT 1



DISPLAY READOUT	EXPLANATION
	Tap INPUT SAT 1 to enter the menu to configure input 1 manually. Rotate the button to go down in the menu.
	DC: Decide whether the input should provide power to an LNB or external amplifier. Choose between OFF, 13V, 13V+TONE, 18V or 18V+TONE.
	TAP the rotary button to ADD TRANSPONDER. Scroll down to see the different transponder settings.
	Select the INPUT and OUTPUT frequency for transponder 1 (between 290 and 2340 MHz). This is done digit by digit. First select the hundreds, then the tens, then the units.
	Select the BANDWIDTH, which can vary between 1 and 64 MHz (in steps of 1 MHz). Once selected, the input LEVEL will be shown on the display.
	When all settings for transponder 1 are chosen, scroll up and tap TRANSP: 1. Scroll down to ADD TRANSPONDER to add another transponder. Now you can also change the settings for this transponder.
	A maximum of 32 transponders can be added across all 4 SAT inputs. Adding more transponders will not be possible, the message MAXIMUM TRANSP. REACHED will show on the display

Note: On page 13 and 14 of this manual, you can find an easy template to prepare the transponder settings.

To delete a transponder, position the arrow on the transponder and press the rotary button 3 seconds.

DISPLAY READOUT	EXPLANATION
	To delete a transponder, position the arrow on the transponder and press the rotary button 3 seconds.
	When you have added all the transponders to INPUT SAT 1, and you want to add transponders to the other inputs, scroll up to the top of the menu (to INPUT SAT 1), tap the button and scroll to the next input. Repeat the previous steps for all input transponders.

OUTPUT SETTINGS

DISPLAY READOUT	EXPLANATION
	Define the OUTPUT LEVEL of the output signal, selectable between 89-112 dB μ V (per 1 dB μ V) and two isolated levels ideal for optical systems: 70 and 83 dB μ V.
	Check the output via a network analyser on the -30dB test port.
	<u>Note:</u> If you have a lot of transponders, it might be necessary to lower the output level A SLOPE of up to -15dB can be set to compensate for cable losses. 0dB means all channels have the same output level, -15dB means the beginning of the band is 15dB weaker than the highest frequencies of the satellite band.

Note: In the OUTPUT menu, you define the output level in dB μ V of the transponders. The Compact Satellite Convertor enough gain to guarantee this output level under all input conditions. In case a slope has been set, the output level indicated on the display will be the output level of the highest frequency transponder.

ADVANCED SETTINGS

DISPLAY READOUT	EXPLANATION
	<p>The language of the Compact Satellite Convertor can be set to English, Italian, Spanish or French.</p> <p>Tap FW VERSION to check the firmware version of the device.</p> <p>Tap SERIAL NUMBER to check the serial number of the device.</p> <p>To format the SD CARD, tap FORMAT CARD.</p>

SD CARD SETTINGS

DISPLAY READOUT	EXPLANATION
	<p>To upload settings from a SD card, tap LOAD SD PRESET. This will copy the configuration file from the SD CARD to the device.</p>
	<p>To save the device settings on the SD CARD, go to SAVE SD PRESET and tap on CREATE PRESET.</p> <p>It is possible to create multiple presets. Therefore, tap CREATE PRESET after each modification of the settings.</p> <p>To delete all presets, press DELETE ALL.</p>

EXIT SETTINGS

DISPLAY READOUT	EXPLANATION
	<p>To avoid unauthorized people changing the settings, the Compact Satellite Convertor can be locked with a security code.</p>
	<p>Select LOCK and SET LOCK CODE.</p> <p>When the lock code is set, the device will shut down.</p> <p>When you restart the device, you will now have to enter the correct lock code.</p> <p>Remark: If you forgot the lock code, you can always use the value 50. This master code is fixed and cannot be changed.</p>
	<p>If you do not want to work with a lock code, go to EXIT and tap NO LOCK.</p>

2. TECHNICAL SPECIFICATIONS

Compact Satellite Convertor – 9780

Inputs	-	4 SAT (wideband/quattro/quad)
Outputs	-	1 main (SAT) + 1 test port (-30dB)
SAT Input Frequency range	MHz	290 - 2340
SAT Output Frequency range	MHz	290 - 2340
SAT Input level	dB μ V	40 - 95
SAT output power (per transponder)	dB μ V	112
SAT output power (35dB/IM3)	dB μ V	132
SAT output level flatness	dB	<1
SAT output level adjustment	dB	20
Slope adjustment	dB	15
SAT Gain	dB	>40
Number of transponders	-	32
Conversion	-	Yes (all 32 transponders)
Transponder Bandwidth	MHz	1 - 64 (per 1 MHz steps)
Selectivity	dB	35 (@ 1MHz)
Return Loss	dB	10
Auto tuning	-	Yes (incoming transponders are copied from input 1 to output)
ESD protection	-	All inputs
DC@ SAT input DC Load current @ SAT input	- mA	13V/18V/Bypass & 0/22kHz selectable by SW 500
SD port	-	Yes (for copy configuration)
Operating temperature	°C	-5 to +50
Power Supply Power Consumption	V W	100 - 240 25
Dimensions	mm	217 x 165 x 59
Weight	kg	0,8

3. SAFETY INSTRUCTIONS



Read these instructions carefully before connecting the unit



To prevent fire, short circuit or shock hazard:

- Do not expose the unit to rain or moisture.
- Install the unit in a dry location without infiltration or condensation of water.
- Do not expose it to dripping or splashing.
- Do not place objects filled with liquids, such as vases, on the apparatus.
- If any liquid should accidentally fall into the cabinet, disconnect the power plug.



To avoid any risk of overheating:

- Install the unit in a well aired location and keep a minimum distance of 15 cm around the apparatus for sufficient ventilation
- Do not place any items such as newspapers, tablecloths, curtains, on the unit that might cover the ventilation holes.
- Do not place any naked flame sources, such as lighted candles, on the apparatus
- Do not install the product in a dusty place
- Use the apparatus only in moderate climates (not in tropical climates)
- Respect the minimum and maximum temperature specifications



To avoid any risk of electrical shocks:

- Connect apparatus only to socket with protective earth connection.
- The mains plug shall remain readily operable
- Pull out power plug to make the different connections of cables
- To avoid electrical shock, do not open the housing of adapter.



Maintenance



Only use a dry soft cloth to clean the cabinet.



Do not use solvent



For repairing and servicing refer to qualified personnel.



Dispose according your local authority's recycling processes

4. CONDITIONS OF WARRANTY

Unitron N.V. warrants the product as being free from defects in material and workmanship for a period of 24 months starting from the date of production indicated on it. See note below.

If during this period of warranty the product proves defective, under normal use, due to defective materials or workmanship, Unitron N.V, at its sole option, will repair or replace the product. Return the product to your local dealer for reparation.

THE WARRANTY IS APPLIED ONLY FOR DEFECTS IN MATERIAL AND WORKMANSHIP AND DOES NOT COVER DAMAGE RESULTING FROM:

- Misuse or use of the product out of its specifications,
- Installation or use in a manner inconsistent with the technical or safety standards in force in the country where the product is used,
- Use of non-suitable accessories (power supply, adapters...),
- Installation in a defect system,
- External cause beyond the control of Unitron N.V. such as drop, accidents, lightning, water, fire, improper ventilation...

THE WARRANTY IS NOT APPLIED IF

- Production date or serial number on the product is illegible, altered, deleted or removed.
- The product has been opened or repaired by a non-authorized person.

NOTE

Date of production can be found in the product's serial number code. The format will either be "YEAR W WEEK" (e.g., 2017W32 = year 2017 week 32) or "YYWW" (e.g., 1732 = year 2017 week 32).

TEMPLATE FOR PRESET 1

TRANSPONDER	SAT INPUT	INPUT FREQUENCY	OUTPUT FREQUENCY	BANDWIDTH
1	-1-2-3-4-	MHz	MHz	MHz
2	-1-2-3-4-	MHz	MHz	MHz
3	-1-2-3-4-	MHz	MHz	MHz
4	-1-2-3-4-	MHz	MHz	MHz
5	-1-2-3-4-	MHz	MHz	MHz
6	-1-2-3-4-	MHz	MHz	MHz
7	-1-2-3-4-	MHz	MHz	MHz
8	-1-2-3-4-	MHz	MHz	MHz
9	-1-2-3-4-	MHz	MHz	MHz
10	-1-2-3-4-	MHz	MHz	MHz
11	-1-2-3-4-	MHz	MHz	MHz
12	-1-2-3-4-	MHz	MHz	MHz
13	-1-2-3-4-	MHz	MHz	MHz
14	-1-2-3-4-	MHz	MHz	MHz
15	-1-2-3-4-	MHz	MHz	MHz
16	-1-2-3-4-	MHz	MHz	MHz
17	-1-2-3-4-	MHz	MHz	MHz
18	-1-2-3-4-	MHz	MHz	MHz
19	-1-2-3-4-	MHz	MHz	MHz
20	-1-2-3-4-	MHz	MHz	MHz
21	-1-2-3-4-	MHz	MHz	MHz
22	-1-2-3-4-	MHz	MHz	MHz
23	-1-2-3-4-	MHz	MHz	MHz
24	-1-2-3-4-	MHz	MHz	MHz
25	-1-2-3-4-	MHz	MHz	MHz
26	-1-2-3-4-	MHz	MHz	MHz
27	-1-2-3-4-	MHz	MHz	MHz
28	-1-2-3-4-	MHz	MHz	MHz
29	-1-2-3-4-	MHz	MHz	MHz
30	-1-2-3-4-	MHz	MHz	MHz
31	-1-2-3-4-	MHz	MHz	MHz
32	-1-2-3-4-	MHz	MHz	MHz

TEMPLATE FOR PRESET 2

TRANSPONDER	SAT INPUT	INPUT FREQUENCY	OUTPUT FREQUENCY	BANDWIDTH
1	-1-2-3-4-	MHz	MHz	MHz
2	-1-2-3-4-	MHz	MHz	MHz
3	-1-2-3-4-	MHz	MHz	MHz
4	-1-2-3-4-	MHz	MHz	MHz
5	-1-2-3-4-	MHz	MHz	MHz
6	-1-2-3-4-	MHz	MHz	MHz
7	-1-2-3-4-	MHz	MHz	MHz
8	-1-2-3-4-	MHz	MHz	MHz
9	-1-2-3-4-	MHz	MHz	MHz
10	-1-2-3-4-	MHz	MHz	MHz
11	-1-2-3-4-	MHz	MHz	MHz
12	-1-2-3-4-	MHz	MHz	MHz
13	-1-2-3-4-	MHz	MHz	MHz
14	-1-2-3-4-	MHz	MHz	MHz
15	-1-2-3-4-	MHz	MHz	MHz
16	-1-2-3-4-	MHz	MHz	MHz
17	-1-2-3-4-	MHz	MHz	MHz
18	-1-2-3-4-	MHz	MHz	MHz
19	-1-2-3-4-	MHz	MHz	MHz
20	-1-2-3-4-	MHz	MHz	MHz
21	-1-2-3-4-	MHz	MHz	MHz
22	-1-2-3-4-	MHz	MHz	MHz
23	-1-2-3-4-	MHz	MHz	MHz
24	-1-2-3-4-	MHz	MHz	MHz
25	-1-2-3-4-	MHz	MHz	MHz
26	-1-2-3-4-	MHz	MHz	MHz
27	-1-2-3-4-	MHz	MHz	MHz
28	-1-2-3-4-	MHz	MHz	MHz
29	-1-2-3-4-	MHz	MHz	MHz
30	-1-2-3-4-	MHz	MHz	MHz
31	-1-2-3-4-	MHz	MHz	MHz
32	-1-2-3-4-	MHz	MHz	MHz



www.unitrongroup.com