

Hanging Hardware

PLATINUM TOOLS®

Options for
overhead installation



Hanging Hardware

Hang ceiling wire & jack chain, threaded rod and eye lag screws. Our hardware is designed for the most efficient, secure and cost effective solution.

Features

Various hanging hardware pieces include:

- High quality all steel construction
- Powder actuated with Bluepoint™ pin for fastening to concrete
- Threaded and non-threaded holes to accommodate jack chain, ceiling wire or threaded rod

Applications

- Vertical Overhangs
- Hammer-on
- Threaded Rod
- Powder Actuated
- Eye Lag Screws
- Threaded Rod
- Pressed Beam Clamps

See reverse for
additional information.

Ask about the Xtender Pole

For easier overhead installations. A safer and faster way to install J-hooks, lag screws, ceiling wire, jack chain and rod from the work floor.

P/N JH712 up to 18' ceilings
P/N JH718 up to 24' ceilings



Phone: 800.749.5783
Fax: 800.749.5784

806 Calle Plano
Camarillo, CA 93012

www.platinumtools.com

We Make Connections EZ!

Hanging Hardware

Hangers: Hammer-On

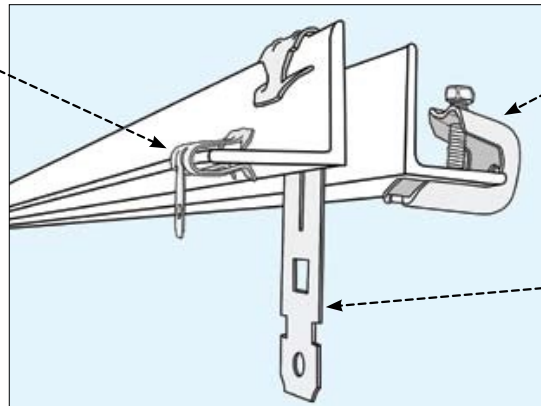
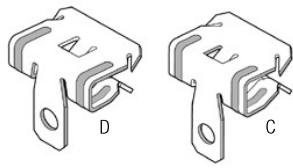

Pressed Beam Clamp

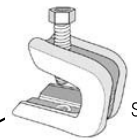

Eye Lag Screws

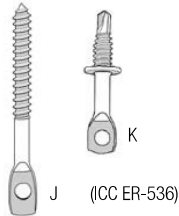

(CC ER-536)

Hangers: Vertical & Angled

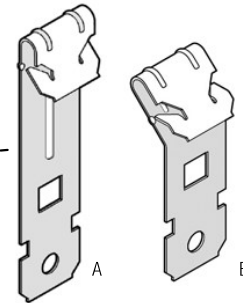

Threaded Rod: Male Couplers

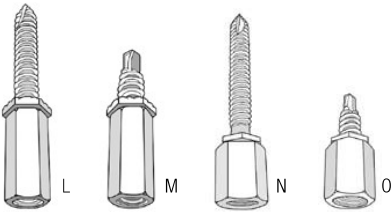

Mult-Function Clip: Bat Wing

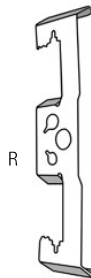

Angled Clips: Threaded Hole and Powder Actuated

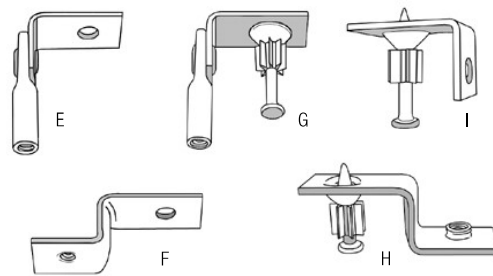

Hanging Hardware

Part No.	Description	Qty	UPC Code
A	JH901-100 Hanger - Vertical Overhang 180° with 1/4" Hole	100/Box	899740003903
B	JH902-100 Hanger - Angled Overhang 45° with 1/4" Hole	100/Box	899740003958
C	JH910-100 Hanger - Hammer On 1/8 Thru 1/4" with 1/4" Hole	100/Box	899740003897
D	JH911-100 Hanger - Hammer On 5/16 Thru 1/2" with 1/4" Hole	100/Box	899740003965
E	JH920-100 Angle Clip - Threaded Rod RT 1/4-20 with 1/4" Hole	100/Box	899740003941
F	JH921-100 Angle Clip - Threaded Rod Z with 1/4-20 Threaded Hole & 1/4" Hole	100/Box	899740003927
G	JH930-100 Angle Clip - Threaded Rod RT 1/4-20 with Powder Actuated Nail	100/Box	899740003934
H	JH931-50 Angle Clip - Threaded Rod Z with Powder Actuated Nail & 1/4-20 Threaded Hole	50/Box	899740003910
I	JH932-100 Angle Clip - Powder Actuated Pin with 1/4" Hole	100/Box	899740003996
J	JH940-100 Eye Lag Screw - 1/4", 3" Overall Length (Wood Applications)	100/Box	899740004016
K	JH941-100 Eye Lag Screw - 2" Overall Self Drill, 1/4" Hole & 3/4" Thread Length (16-22 Gauge, Sheet Metal Applications)	100/Box	899740004009
L	JH950-100 Threaded Rod - 1/4-20 Male Coupler with 1 1/2" Sharp Point Screw (Wood Applications)	100/Box	899740004023
M	JH951-100 Threaded Rod - 1/4-20 Male Coupler with 3/4" Self Drill Screw (16-22 Gauge, Sheet Metal Applications)	100/Box	899740004030
N	JH952-100 Threaded Rod - 3/8-16 Male Coupler with 2" Long Sharp Point Screw (Wood Applications)	100/Box	899740004047
O	JH953-100 Threaded Rod - 3/8-16 Male Coupler with 3/4" Long Self Drill Screw (16-22 Gauge, Sheet Metal Applications)	100/Box	899740004054
P	JH975 Installation Tool - Vertical (JH901-100) and Angled Overhang (JH902-100)	1/Bag	899740003989
Q	JH980 Installation Tool - Eye Lag Driver – Fits Into Any Drill, 1/4" HEX	1/Bag	899740003972
R	JH960-100 Multi-Function Clip - Bat Wing	100/Box	899740005433
S	JH965-50 Pressed Beam Clamp for 1/2" Flanges, 1/4-20 Threaded Rod	50/Box	899740005440

Installation Tools: Vertical Overhang & Eye Lag Driver

