

# Swivel Mount for Curved TVs

**INCREASE THE VIEWING RANGE IN YOUR ROOM**

The SANUS model VLC1 Swivel Mount was designed specifically for use with curved TVs. Engineered with 10° of swivel left and right, the ideal viewing range is increased by 20°\* making your seat in the room, the best seat. Fits curved TVs 40"–88" and up to 150 lbs.

\*When compared to an unmounted curved TV.

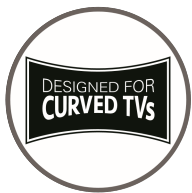

Perfect for use with curved TVs

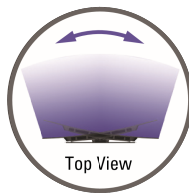

Swivel your TV up to 20° for perfect viewing anywhere in the room

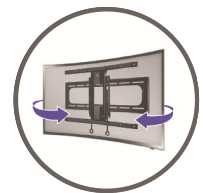

Smooth motion for easy adjustment of TV position

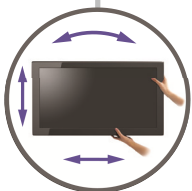
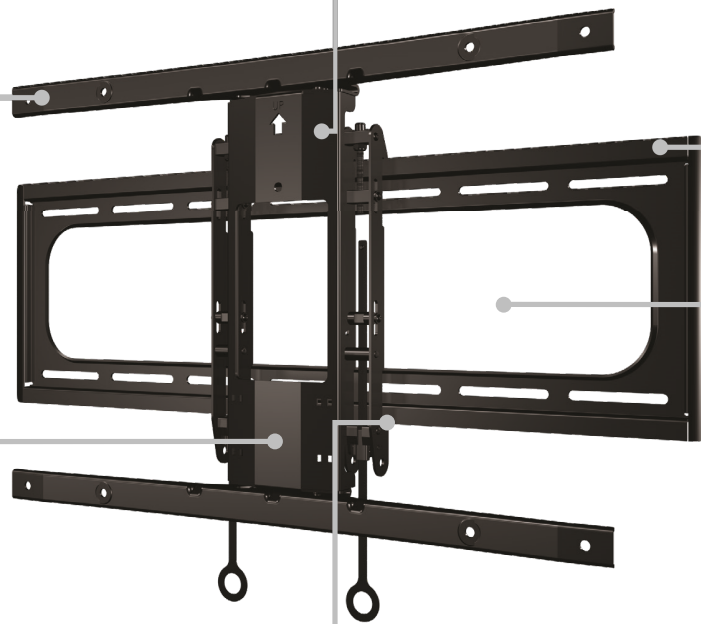

Allows height, level and side-to-side adjustments after installation



Audible click ensures a secure attachment you can hear

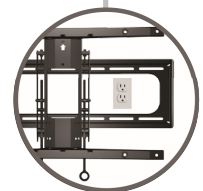

Open design allows mounting over wall boxes and electrical outlets

**TV SIZE RANGE**

40"–88" / 101.6 – 223.5 cm

**WEIGHT CAPACITY**

150 lbs / 68 kg\*  
\*Steel stud applications: 130 lbs / 58.9 kg

**DIMENSIONS (W X D X H)**

30" x 2.68" x 16.97" / 76.2 x 6.8 x 43.1 cm

**MOUNTING PATTERNS**

400 x 400 | 600 x 400

# Curved TVs Are Better With SANUS Swivel Mount

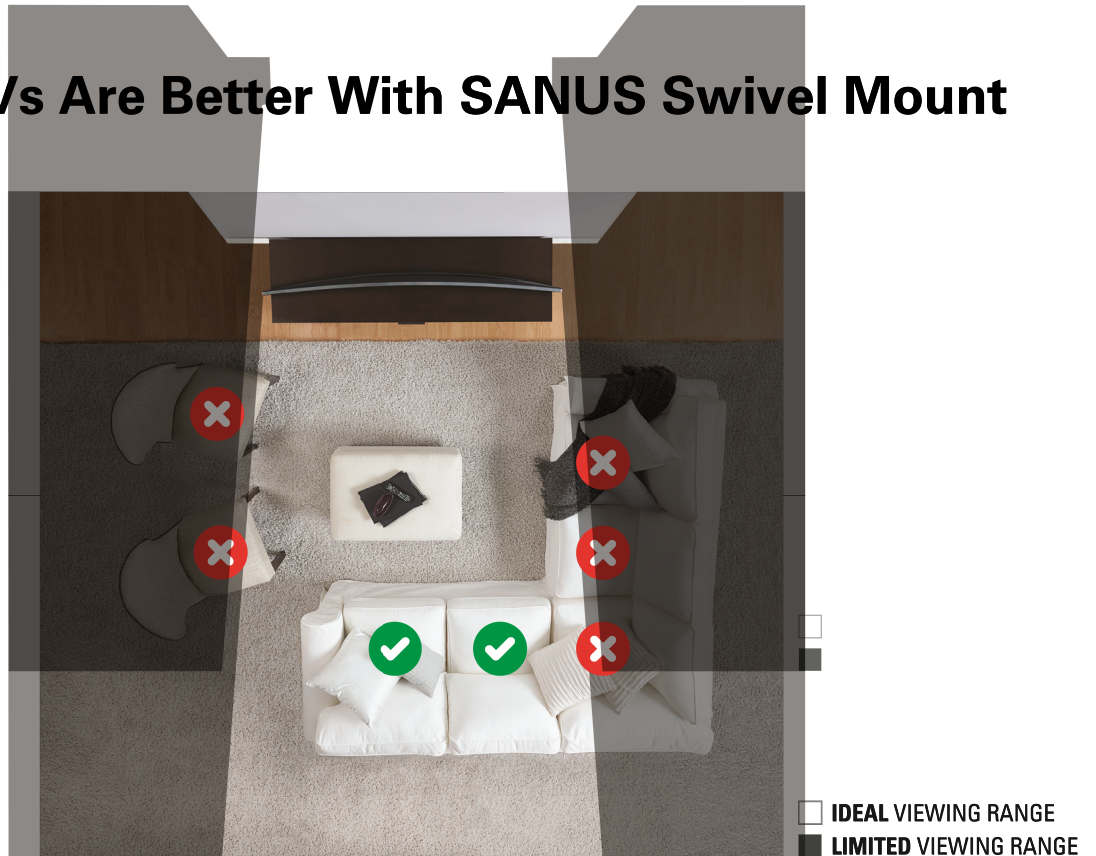

## CURVED TV UNMOUNTED

On either end of the curved TV, the screen is approximately 8–10° off parallel. This means that curved TVs have a 15–20° reduced functional viewing angle when compared to standard flat panel TVs. The ideal viewing angle of a curved TV is even more limited, resulting in fewer viewing locations in a room.



## CURVED TV WITH SWIVEL MOUNT

Horizontal rotation is critical to most curved TV installations. The SANUS model VLC1 Swivel Mount design, with 10° of swivel left and right, brings the leading edge of the TV past parallel to the wall, increasing the ideal viewing range by 20°. This allows for additional ideal viewing locations within the same room.